

3 ARRAY
scale 1:7

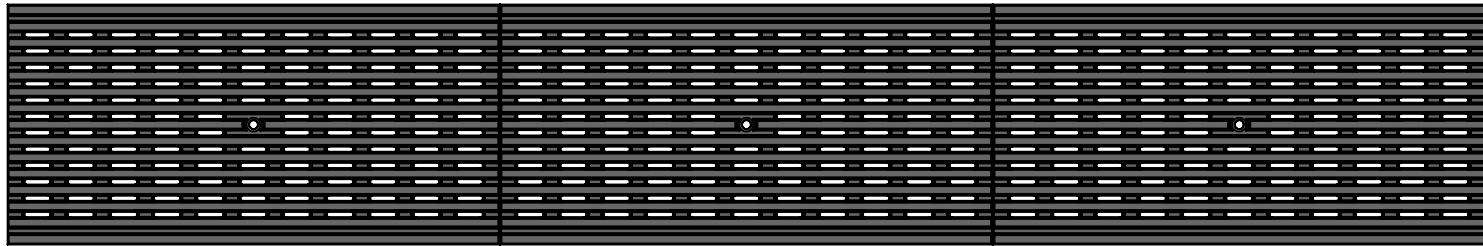

TOP VIEW
scale 1:4

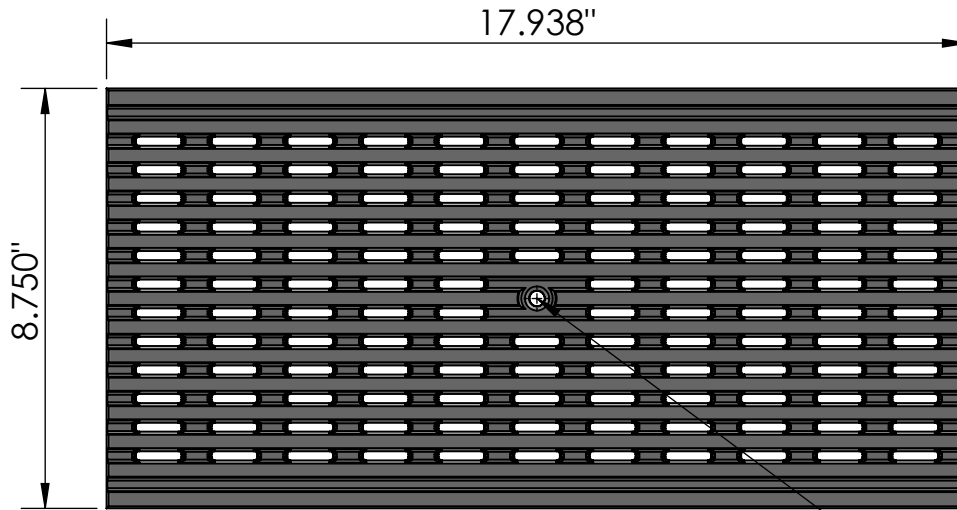

CASTING-ID
scale 1:2

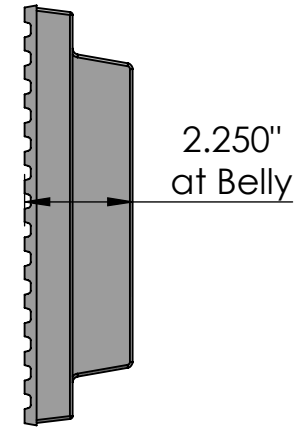
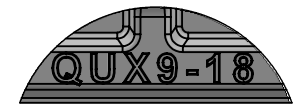

1/4"-20
Pan Hea
STD-Bolt

SIDE VIEW
scale 1:4

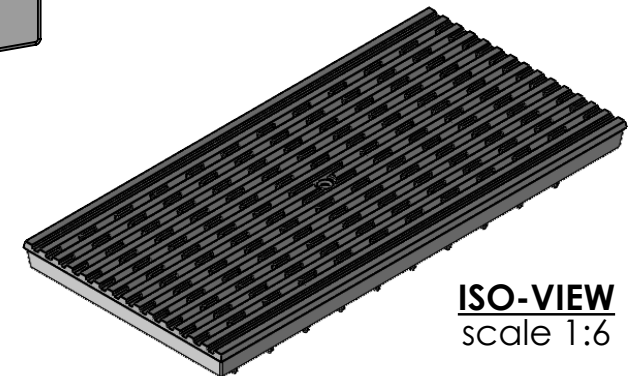
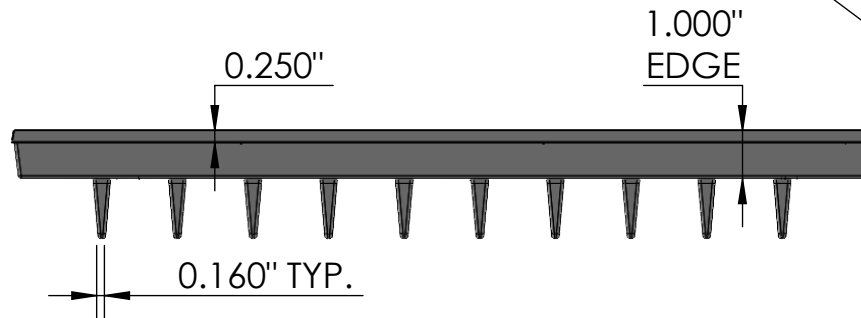

ISO-VIEW
scale 1:6

NOTES:

1. Heelproof: No thru openings greater than 1/4".
2. Ships in pieces: 1
3. Due to casting inconsistencies, all dimensions are nominal.

Made in USA ©2020 Iron Age Designs

Que 9" x 18" Trench Grate - Heel Proof, Heavy Duty

| | | | | |
|--|--|--------------------------------------|--|---|
|  IRON AGE DESIGNS Telephone 206.276.0925 www.ironagegrates.com | Material: Ductile Iron 65-45-12 | Weight: 25.87 lbs. | Free Drain Area: 22.63 in/sq., or 14.42 % | By: MS Checked: MS Date: 2-11-22 |
| | Finish: Raw | Edge: 1.000" | Flow Rate: 29.65 GPM, or .066 CuFt./sec. | © Registration: Pending Scale: NTS |
| | Fits: Iron Age Custom Frames SOLD SEPARATELY | Product ID: QUX9-18I99HPHD | Drawing Name: 01_QUE_Z_9x18HPHD_TrenchGrate | |