

3 ARRAY
scale 1:7

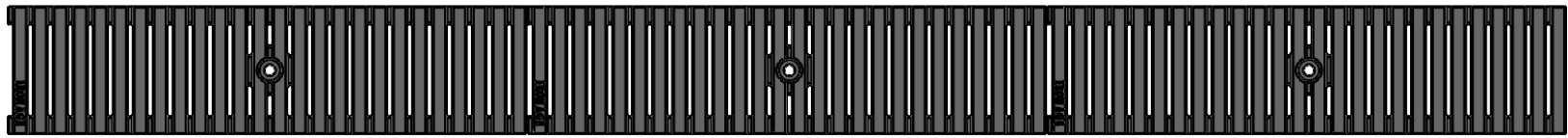

TOP VIEW
scale 1:4

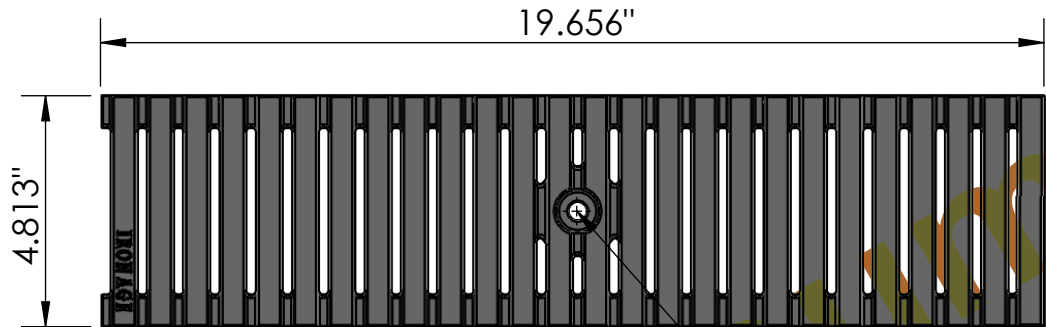

END VIEW
scale 1:4

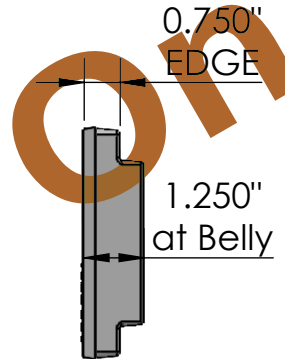

CASTING-ID
scale 1:2

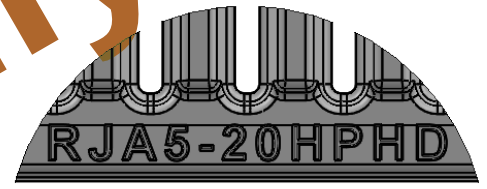

SIDE VIEW
scale 1:4

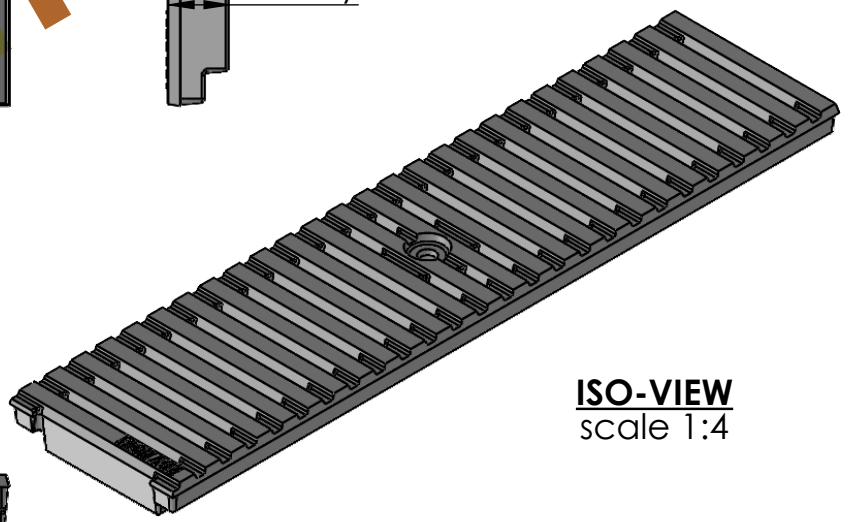
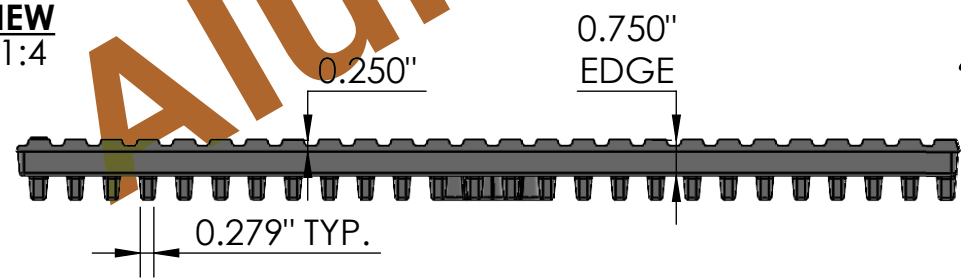

ISO-VIEW
scale 1:4

5/16"-18
Pan Head
STD-Bolt

NOTES:

1. Heelproof: No thru openings greater than 1/4".
2. Ships in pieces: 1
3. Due to casting inconsistencies, all dimensions are nominal.

Made in USA ©2007 Iron Age Designs

Regular Joe 5" x 20" Trench Grate - Heel Proof - Heavy Duty

 IRON AGE DESIGNS Telephone 206.276.0925 www.ironagegrates.com	Material: Cast Aluminum 356-T6	Weight: 5.93 lbs.	Free Drain Area: 15.84 in/sq., or 16.75 %	By: RJ Checked: MS Date: 6-7-24
	Finish: Raw	Edge: 0.750"	Flow Rate: 20.75 GPM, or .046 CuFt./sec.	© Registration: Pending Scale: NTS
	Fits: ACO® K100	Product ID: RJA520A99HPHD	Drawing Name: 001_JOE_5x20_HP HD_TrenchGrate_Aluminum356-T6	