

TOP VIEW
scale 1:14

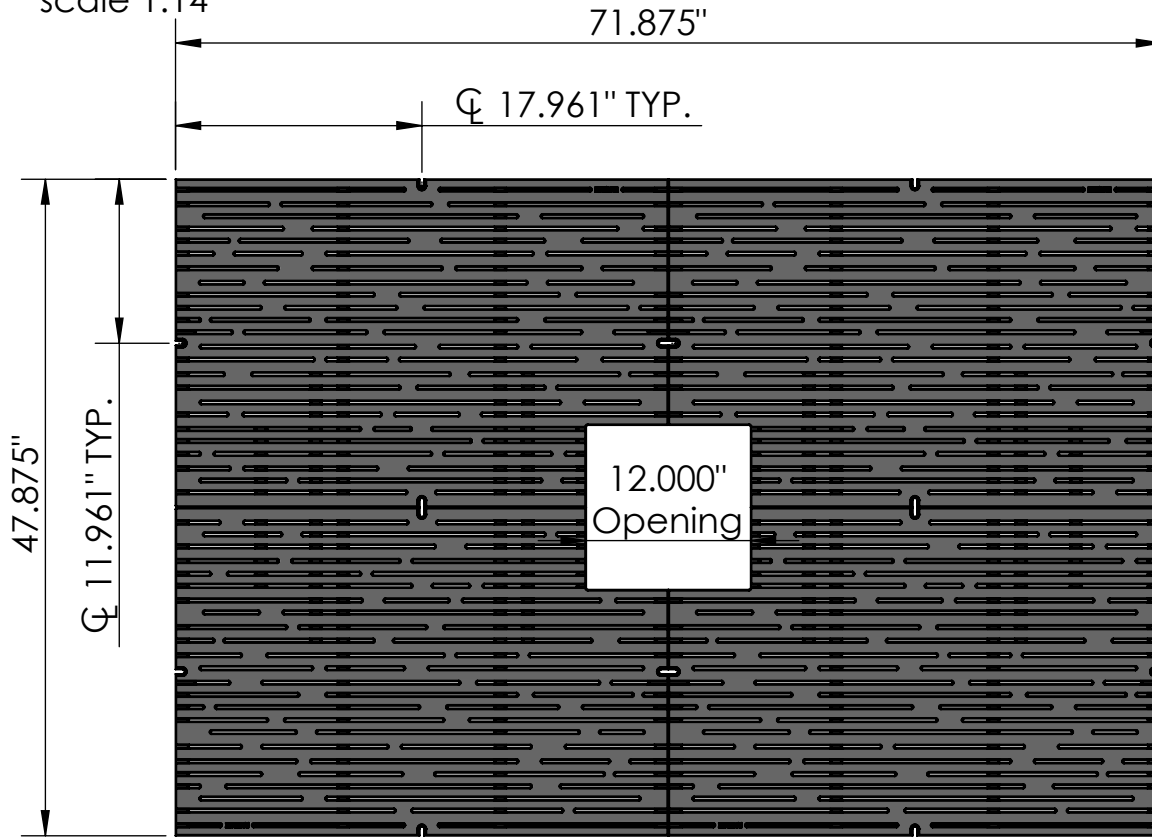

CASTING-ID
scale 1:2

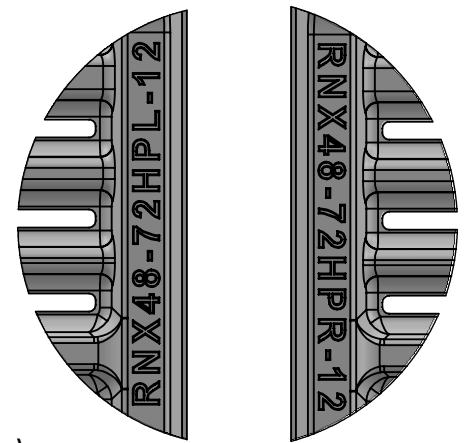

ISO-VIEW
scale 1:22

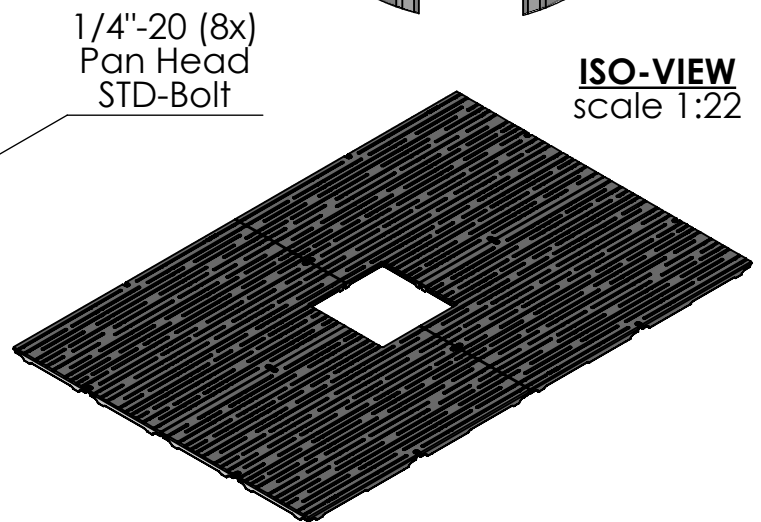

SIDE VIEW
scale 1:14

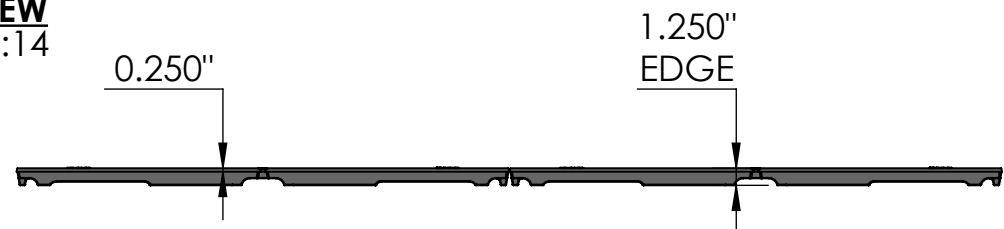

NOTES:

1. Heelproof: No thru openings greater than 1/4".
2. Pieces per Set: 4
3. Due to casting inconsistencies, all dimensions are nominal.
4. Center Opening Options:
Cast at 12" only.
5. Pedestrian Load Only.

Rain 4' x 6' Tree Grate - Heelproof

Made in USA ©2020 Iron Age Designs

<p>IRON AGE DESIGNS Telephone 206.276.0925 www.ironagegrates.com</p>	Material: Ductile Iron 65-45-12 or better Finish: Raw Fits: Iron Age Custom Frame SOLD SEPARATELY	Weight: 302.08 lbs. Edge: 1.250" Product ID: RNX48-72199TGHP	Free Drain Area: 451.94 in/sq. or 13.72 % Flow Rate: 592.05 GPM Drawing Name: 01_RAI_I_48x72HP_TreeGrate_12open_NoCores	By: MS Checked: MS Date: 6-2-23 © Registration: VA 2-246-548 Scale: NTS
	<p>Made in USA ©2020 Iron Age Designs</p>			
	<p>Page 1</p>			

TOP VIEW
scale 1:8

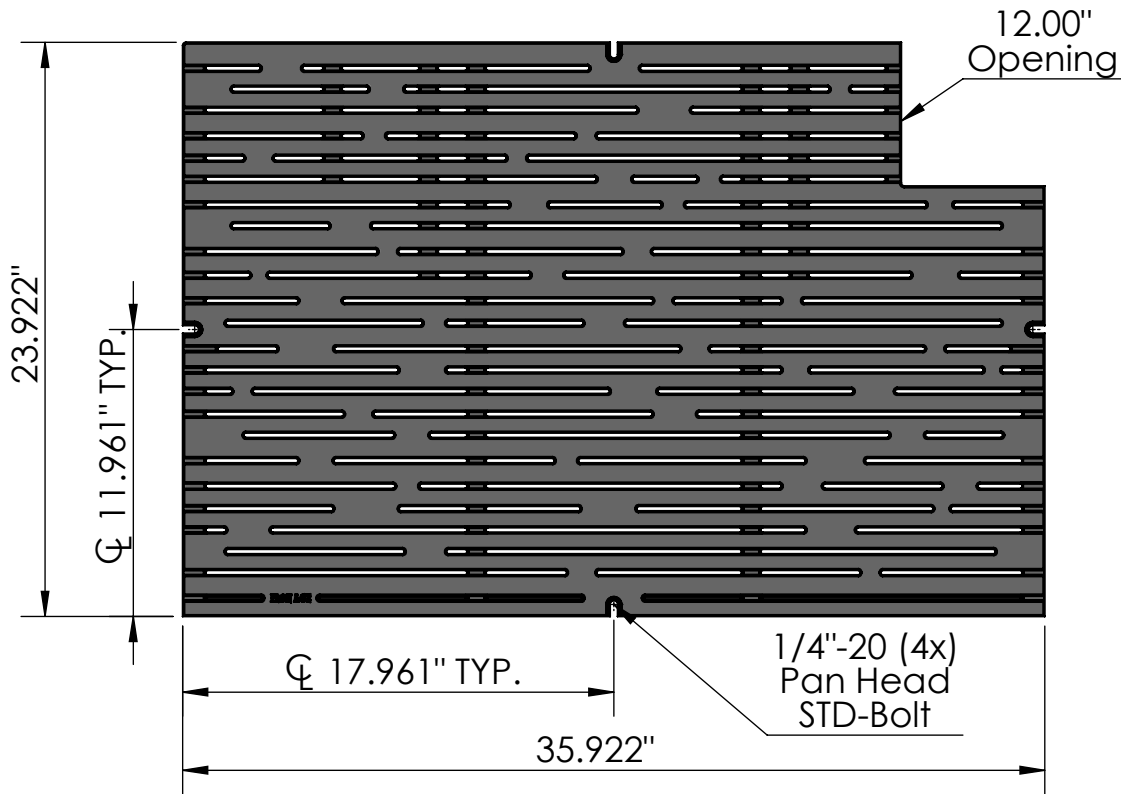

CASTING-ID
scale 1:2

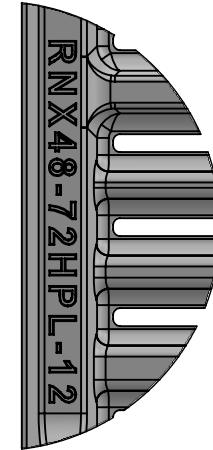

ISO-VIEW
scale 1:12

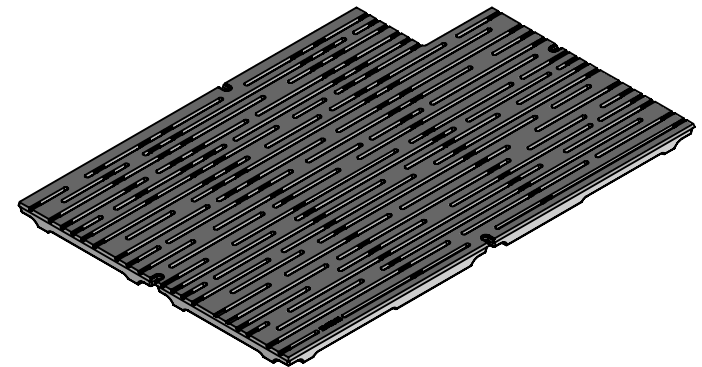

SIDE VIEW
scale 1:8

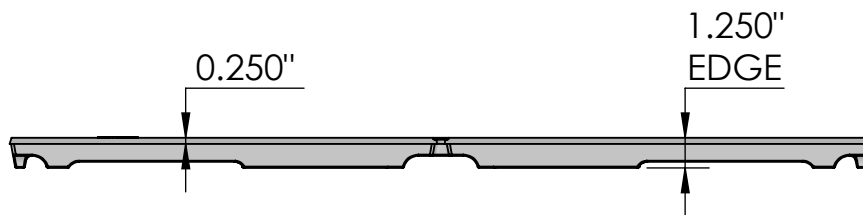

Rain 4' x 6' Tree Grate - Heelproof - Left Panel

NOTES:

1. Heelproof: No thru openings greater than ¼".
2. Due to casting inconsistencies, all dimensions are nominal.
3. Pedestrian Load Only.

Made in USA

©2020 Iron Age Designs

 IRON AGE DESIGNS Telephone 206.276.0925 www.ironagegrates.com	Material: Ductile Iron 65-45-12 or better Finish: Raw	Weight: 75.53 lbs. Edge: 1.250"	Free Drain Area: 112.87 in/sq. or 13.70 % Flow Rate: 147.86 GPM	By: MS Checked: MS Date: 6-2-23 © Registration: VA 2-246-548 Scale: NTS	
	Fits: Iron Age Custom Frame SOLD SEPARATELY	Product ID: RNX48-72I99TGHP	Drawing Name: 02_RAI_I_48x72HP_TreeGrate_12open_NoCore		
					Page 2

TOP VIEW

scale 1:8

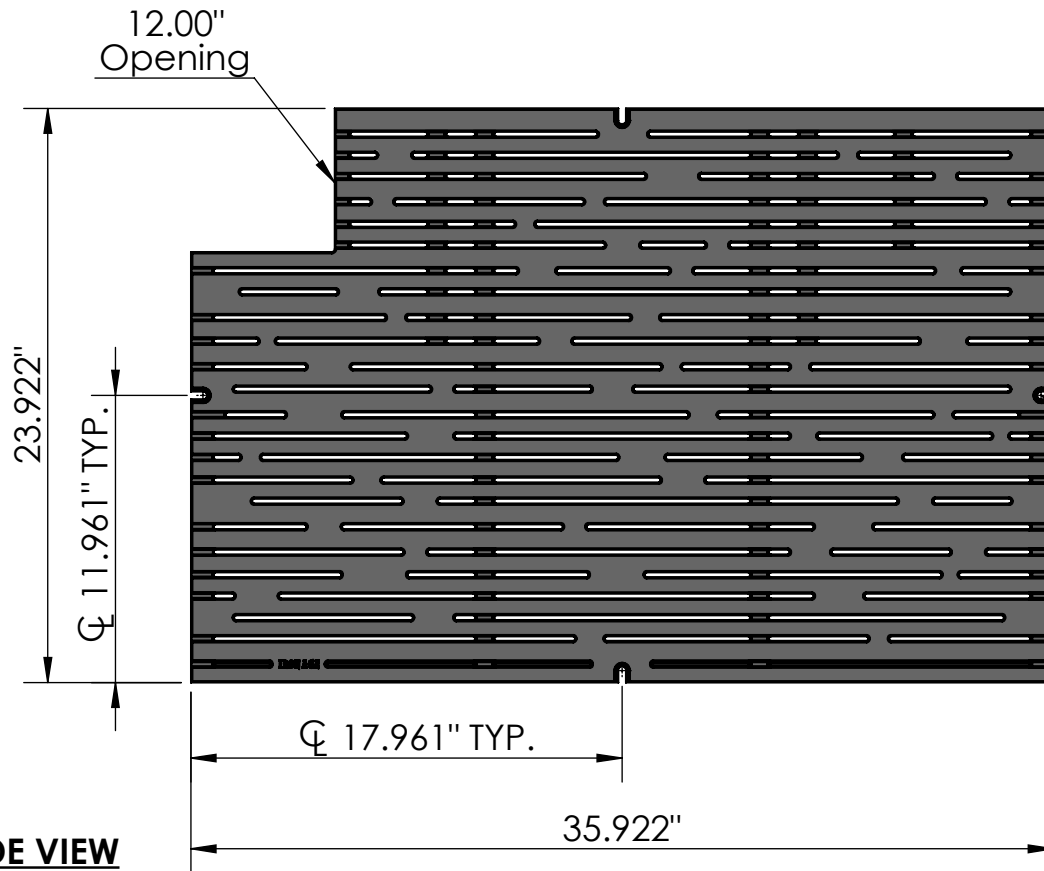

CASTING-ID

scale 1:2

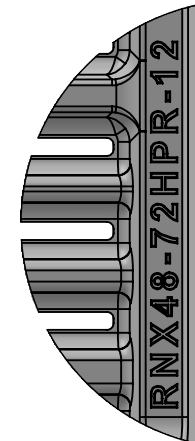

ISO-VIEW

scale 1:12

1/4"-20 (4x)
Pan Head
STD-Bolt

SIDE VIEW

scale 1:8

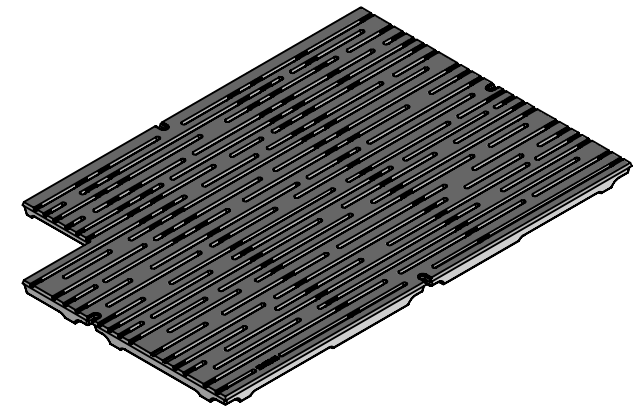
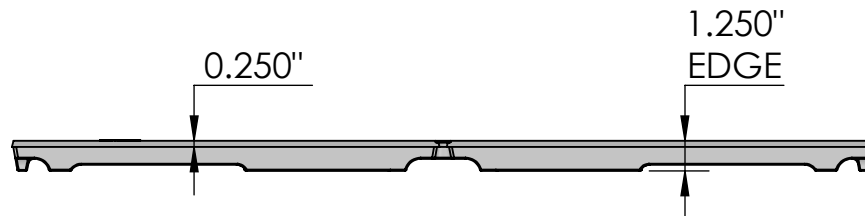

NOTES:

1. Heelprof: No thru openings greater than 1/4".
2. Due to casting inconsistencies, all dimensions are nominal.
3. Pedestrian Load Only.

Made in USA

©2020 Iron Age Designs

Rain 4' x 6' Tree Grate - Heelproof - Right Panel

 IRON AGE DESIGNS Telephone 206.276.0925 www.ironagegrates.com	Material: Ductile Iron 65-45-12 or better	Weight: 75.51 lbs.	Free Drain Area: 113.10 in/sq. or 13.73 %	By: MS	Checked: MS	Date: 6-2-23
	Finish: Raw	Edge: 1.250"	Flow Rate: 148.16 GPM	© Registration: VA 2-246-548		Scale: NTS
	Fits: Iron Age Custom Frame SOLD SEPARATELY	Product ID: RN48-72I99TGHP	Drawing Name: 02_RAI_I_48x72HP_TreeGrate_12open_NoCore			