

TOP VIEW
scale 1:14

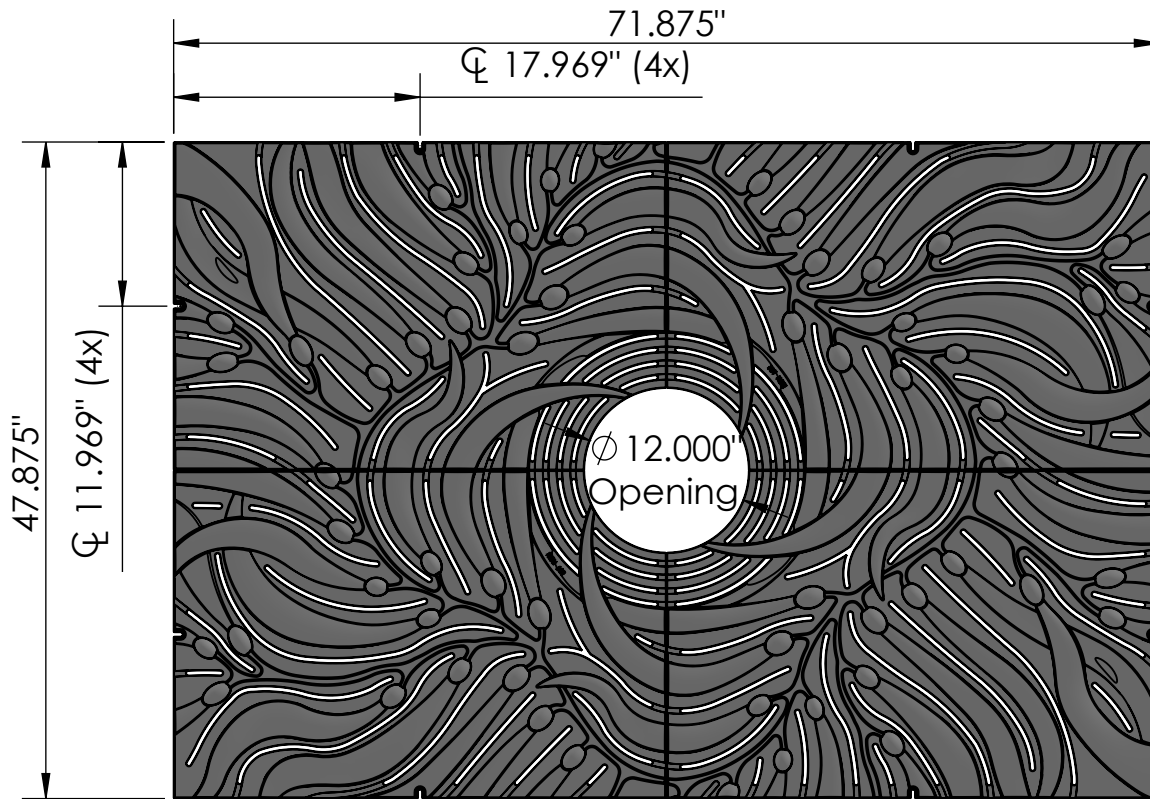

CASTING-ID
scale 1:2

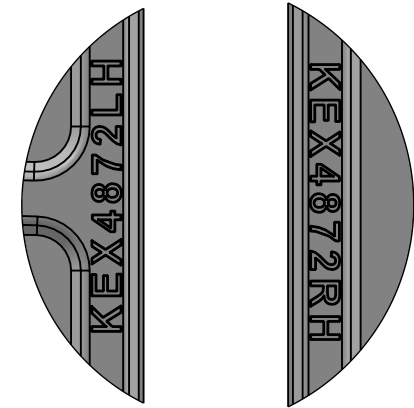

1/4"-20 (16x)
Pan Head
STD-Bolt

ISO-VIEW
scale 1:22

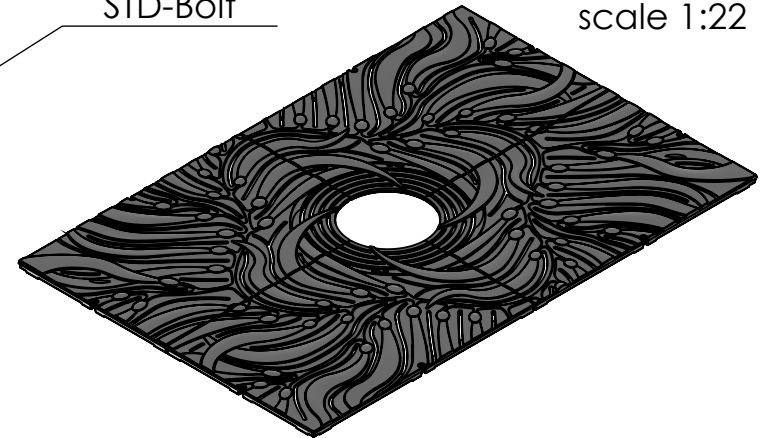

SIDE VIEW
scale 1:14



NOTES:

1. ADA-Compliant: No thru openings greater than 1/2".
2. Pieces per Set: 4
3. Due to casting inconsistencies, all dimensions are nominal.
4. Center Opening Options:
Cast at 12", or Breakouts at 14", 16", 18" & 20".
5. Pedestrian Load Only.

Made in USA

©2010 Iron Age Designs

Kelp 4' x 6' Tree Grate

 IRON AGE DESIGNS Telephone 206.276.0925 www.ironagegrates.com	Material: Ductile Iron CL 80 or better	Weight: 368 lbs.	Free Drain Area: 448.16 in/sq. or 13.02 %	By: MS Checked: MS Date: 12-20-22
	Finish: Raw	Edge: 1.250"	Flow Rate: 587.10 GPM	© Registration: Pending Scale: NTS
	Fits: Iron Age Custom Frame SOLD SEPARATELY	Product ID: KEX48-72199TG	Drawing Name: 04-H-KELP.48x72_Comp	

TOP VIEW
scale 1:8

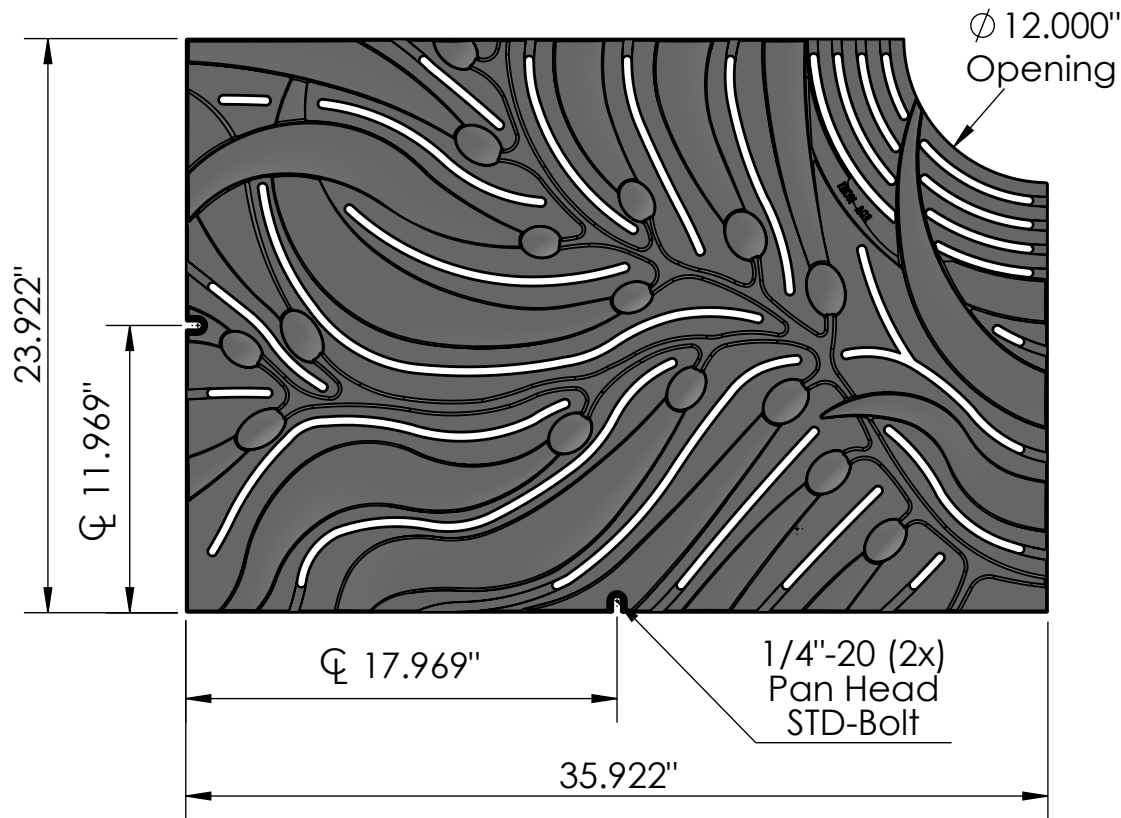

CASTING-ID
scale 1:2

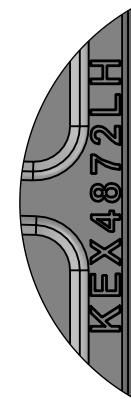

ISO-VIEW
scale 1:12

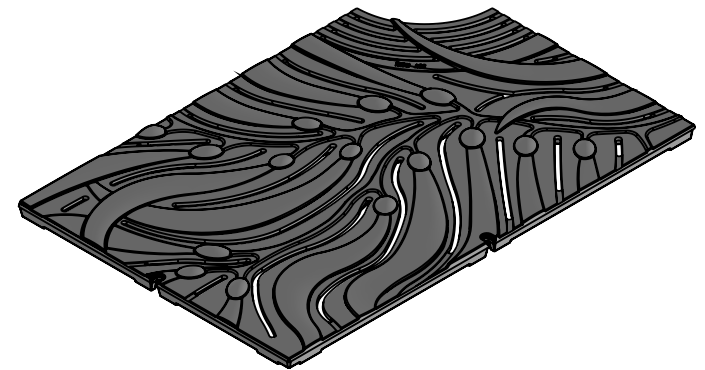

SIDE VIEW
scale 1:8

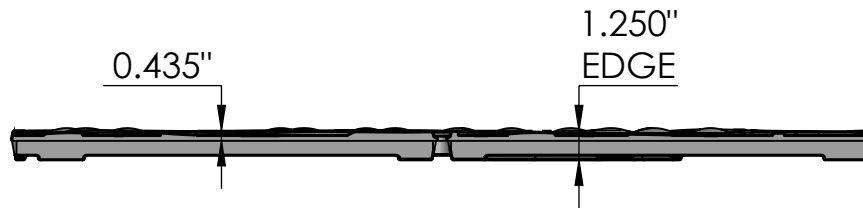

NOTES:

1. ADA-Compliant: No thru openings greater than 1/2".
2. Due to casting inconsistencies, all dimensions are nominal.
3. Pedestrian Load Only.

Made in USA

©2010 Iron Age Designs

Kelp 4' x 6' Tree Grate - Left Panel

 IRON AGE DESIGNS Telephone 206.276.0925 www.ironagegrates.com	Material: Ductile Iron CL 80 or better	Weight: 92.00 lbs.	Free Drain Area: 112.04 in/sq. or 13.02 %	By: MS	Checked: MS	Date: 12-20-22
	Finish: Raw	Edge: 1.250"	Flow Rate: 146.77 GPM	© Registration: Pending		Scale: NTS
	Fits: Iron Age Custom Frame SOLD SEPARATELY	Product ID: KEX48-72I99TGL	Drawing Name: 04-H_KELP.48x72_Comp			

TOP VIEW
scale 1:8

Ø 12.000"
Opening

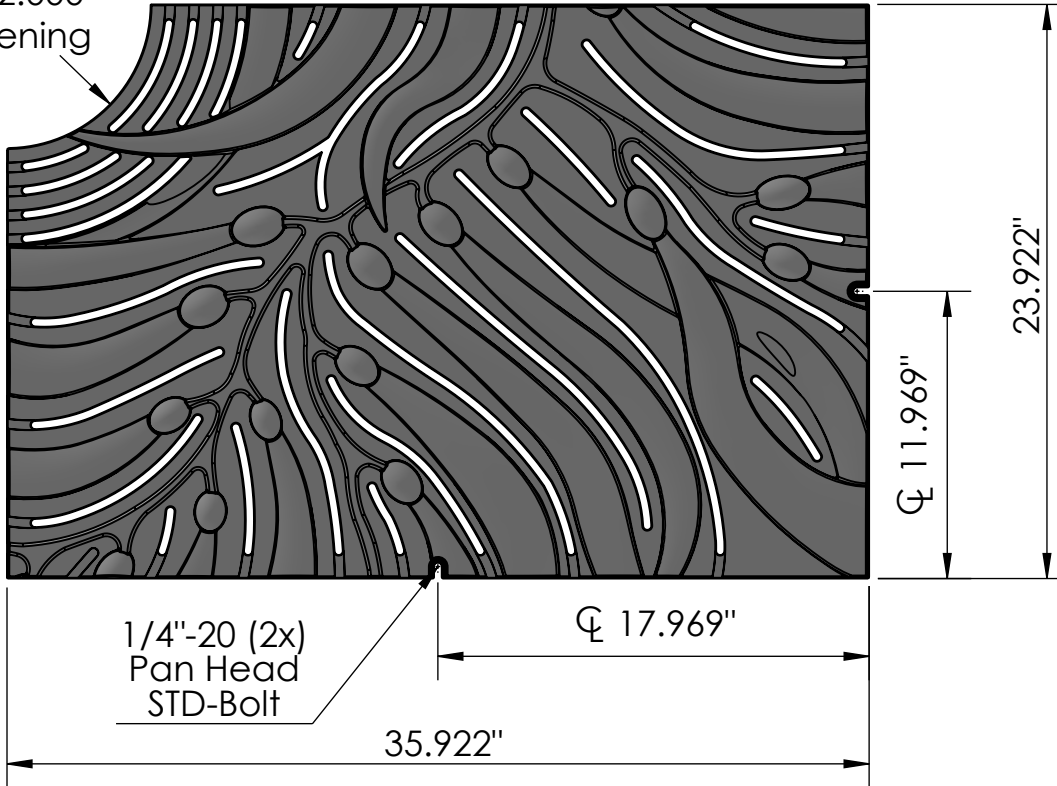

CASTING-ID
scale 1:2

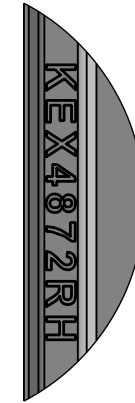

ISO-VIEW
scale 1:12

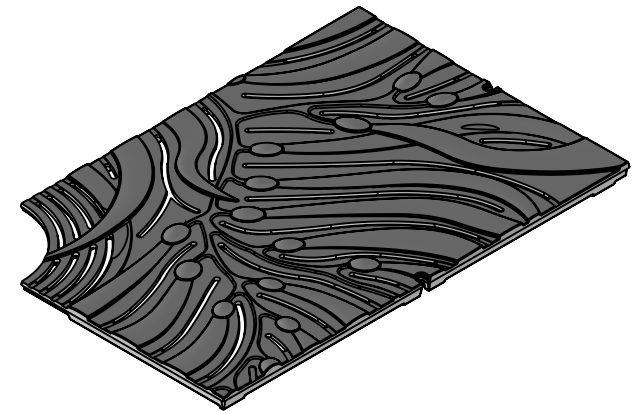

SIDE VIEW
scale 1:8

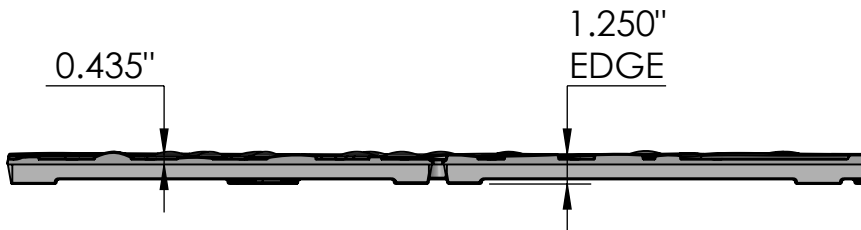

NOTES:

1. ADA-Compliant: No thru openings greater than ½".
2. Due to casting inconsistencies, all dimensions are nominal.
3. Pedestrian Load Only.

Made in USA

©2010 Iron Age Designs

Kelp 4' x 6' Tree Grate - Right Panel

 IRON AGE DESIGNS Telephone 206.276.0925 www.ironagegrates.com	Material: Ductile Iron CL 80 or better	Weight: 92.00 lbs.	Free Drain Area: 112.04 in/sq. or 13.02 %	By: MS Checked: MS Date: 12-20-22
	Finish: Raw	Edge: 1.250"	Flow Rate: 146.77 GPM	© Registration: Pending Scale: NTS
	Fits: Iron Age Custom Frame SOLD SEPARATELY	Product ID: KEX48-72199TGR	Drawing Name: 04-_KELP.48x72_RH	