

TOP VIEW
scale 1:20

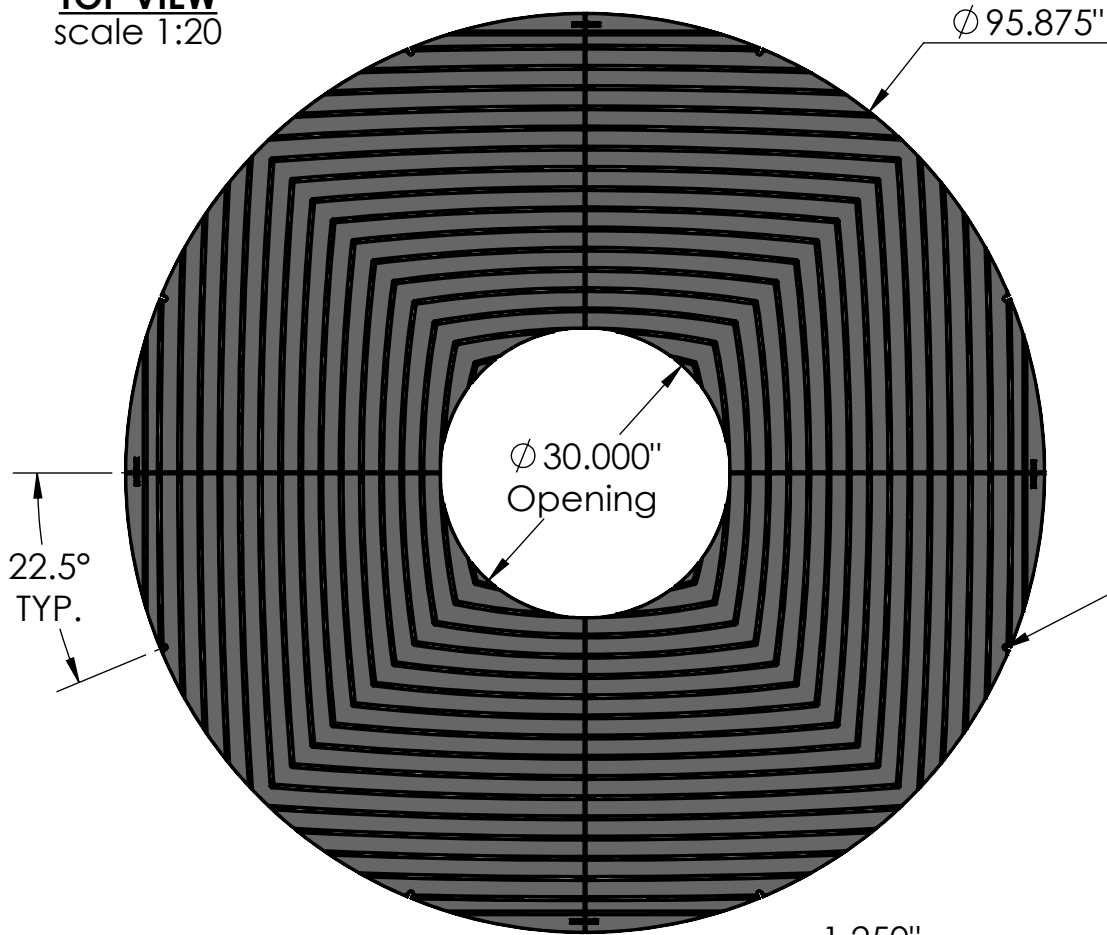

CASTING-ID
scale 1:2

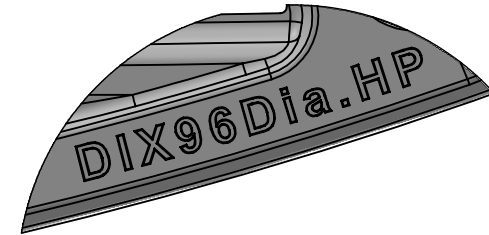

1/4"-20 (8x)
Pan Head
STD-Bolt

ISO-VIEW
scale 1:28

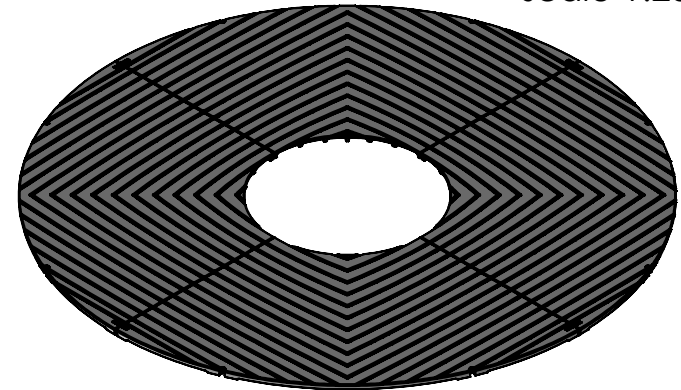

SIDE VIEW
scale 1:20

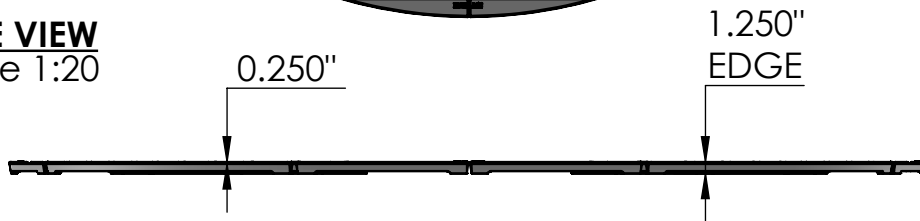

NOTES:

1. Heelproof: No thru openings greater than 1/4".
2. Pieces per Set: 4
3. Due to casting inconsistencies, all dimensions are nominal.
4. Center Opening Options:
Cast at 30".
5. Pedestrian Load Only.

Made in USA

©2019 Iron Age Designs

Divisadero 8' Dia. Tree Grate Heel Proof

 IRON AGE DESIGNS Telephone 206.276.0925 www.ironagegrates.com	Material: Grey Iron CL 30 or better	Weight: 856 lbs.	Free Drain Area: 497.90 in/sq. or 7.65 %	By: MS Checked: MS	Date: 5-21-21
	Finish: Raw	Edge: 1.250"	Flow Rate: 652.25 GPM	© Registration: Pending	Scale: NTS
	Fits: Iron Age Custom Frame SOLD SEPARATELY	Product ID: DIX96DiaI99TGHP	Drawing Name: 01_DIV_I_8'DiaHP_TreeGrate_Comp_30open		

TOP VIEW
scale 1:12

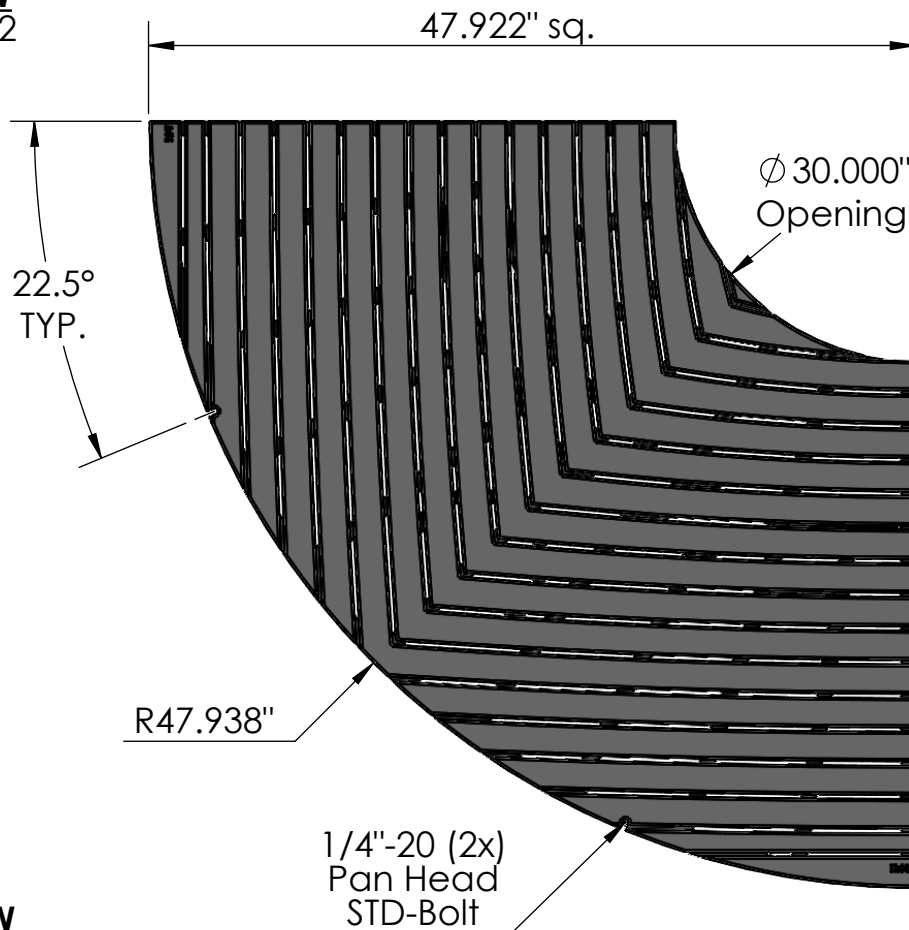

CASTING-ID
scale 1:2

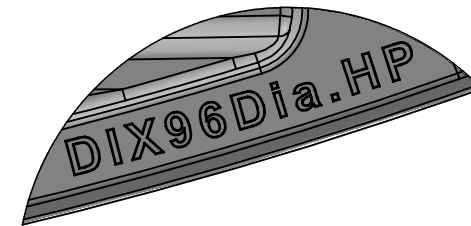

ISO-VIEW
scale 1:16

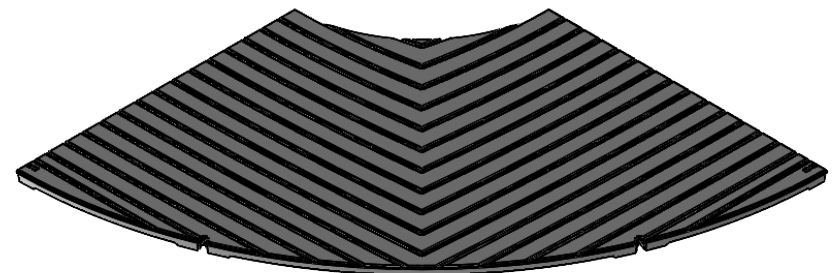

SIDE VIEW
scale 1:12

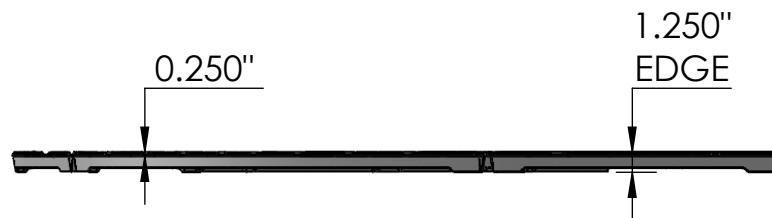

NOTES:

1. Heelproof: No thru openings greater than 1/4".
2. Due to casting inconsistencies, all dimensions are nominal.
3. Pedestrian Load Only.

Made in USA ©2019 Iron Age Designs

Divisadero 8' Dia. Tree Grate Heel Proof - Quarter Panel

 IRON AGE DESIGNS Telephone 206.276.0925 www.ironagegrates.com	Material: Grey Iron CL 30 or better	Weight: 214 lbs.	Free Drain Area: 124.47 in/sq. or 7.65 %	By: MS Checked: MS Date: 5-21-21
	Finish: Raw	Edge: 1.250"	Flow Rate: 163.06 GPM	© Registration: Pending Scale: NTS
	Fits: Iron Age Custom Frame SOLD SEPARATELY	Product ID: DIX96DiaI99TGHP	Drawing Name: 01_DIV_I_8'DiaHP_TreeGrate_30open	